

### Sluiten – Closing - Schliessen

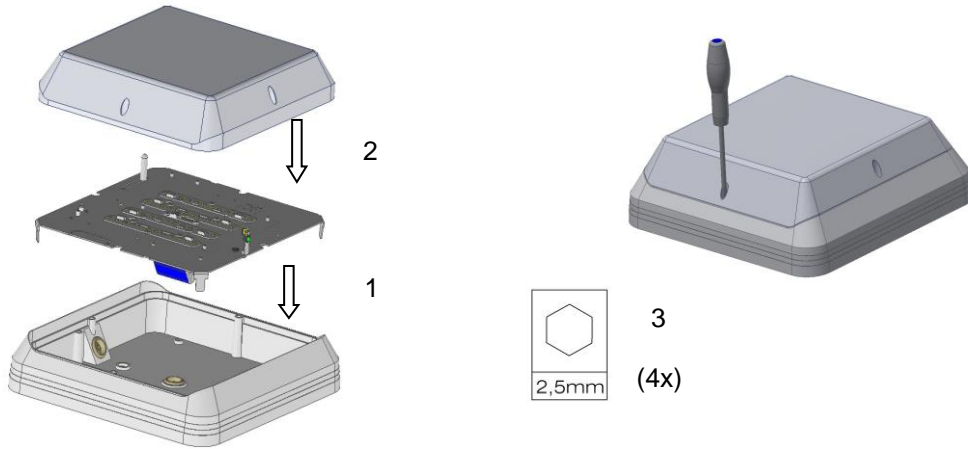

### Schoonmaken – Cleaning - Reinigen

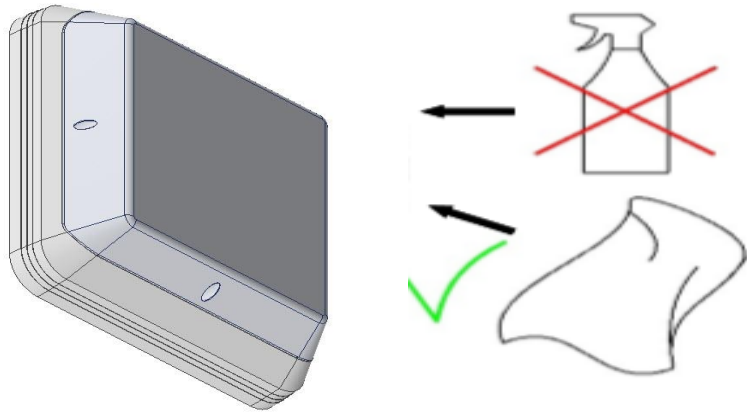

#### Disclaimer

**NL-** Alle informatie, ontwerp en specificaties die in deze handleiding zijn opgenomen waren ten tijde van publicatie correct. Echter, omdat het product continu in verbetering is, kan het uiteindelijke product enigszins afwijken van de functionaliteit die in deze handleiding is vermeld.

**EN-** All information, design and specifications in this manual, were correct when published. Yet: because this product is constantly being improved, the final product can be slightly different to the functionality that is represented in this manual.

**DE-** Alle Informationen, Design und Spezifikationen in dieser Anleitung waren korrekt zur Zeit Publikation. Dennoch: weil dieses Produkt konstant verbessert wird, kann das endliche Produkt etwas anders sein als in dieser Anleitung dargestellt ist.



LIGHTRONICS B.V.  
Spiuweg 19  
5145 NE Waalwijk, NL  
Postbus 150  
5140 AD Waalwijk, NL

Tel: +31(0)416 568 600  
Fax: +31(0)416 568 601  
E-mail: info@lightronics.nl  
www.lightronics.nl



### TPB

Revisie 2  
04-05-2017



TPB

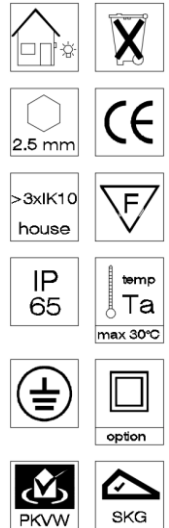

### Hoofdafmetingen (mm) - Main dimensions (mm) - Hauptabmessungen (mm)

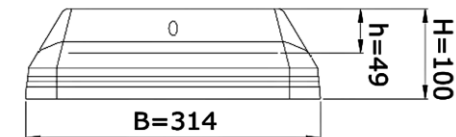
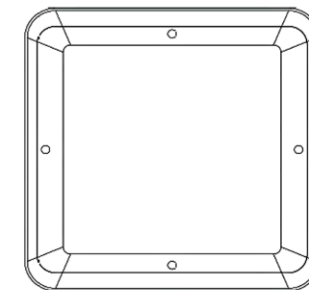
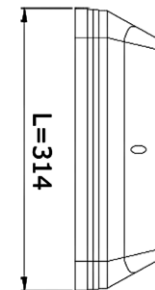

Openen armatuur – Opening luminaire – Öffnen Leuchte



(2x)

1

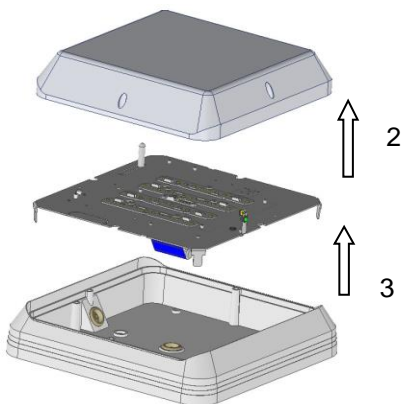
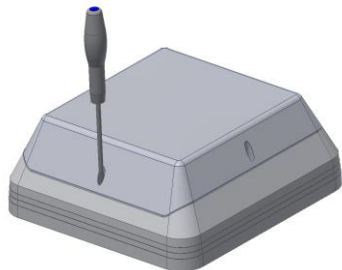

Montage – Mounting - Montage

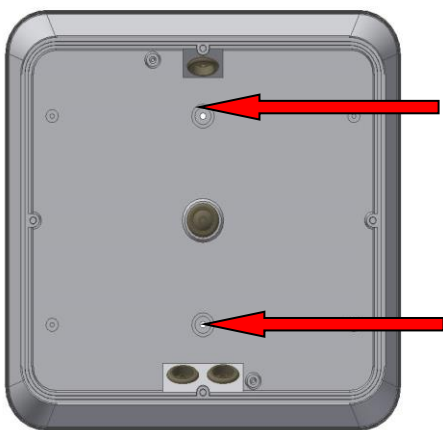

Ø5mm  
(2x)

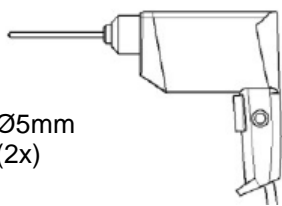

4x45mm



Plug  
6x50mm

Aansluiten – Installing - Anschliessen

OFF/0 !

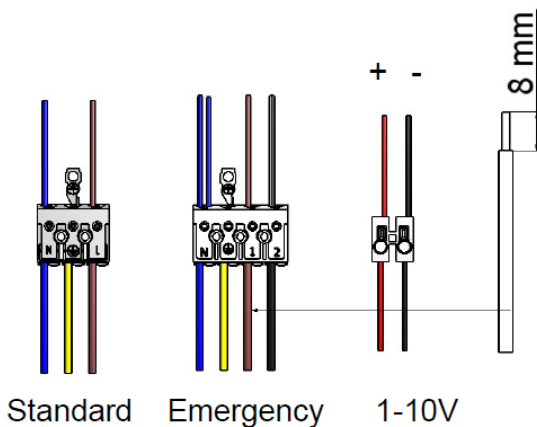
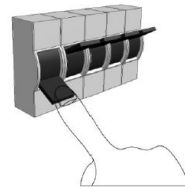

Lampvervanging TCS – Relamping TCS – Leuchtmittelwechsel TCS

