



STREET AND OUTDOOR LIGHTING - POLE TOP LUMINAIRE

One standard for all applications!



Smart City Ready

* Option

PRUNUS A1

Application areas

- 
Residential areas
- 
Plazas
- 
Parks
- 
Business parks
- 
Town and city centres
- 
Separate cycle paths

Top cover: aluminium, coated
 Light cover: UV-stabilised polycarbonate, clear
 Light source: LED

- IP 66
- IK 10
- CE

Dimensions in mm:

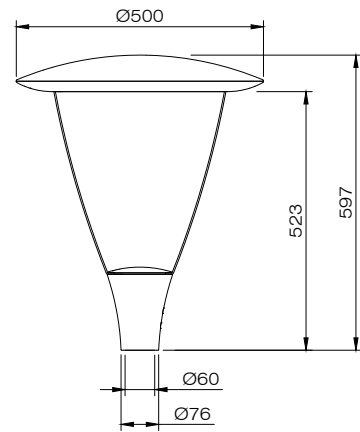



Technical specifications



POLETOP LUMINAIRE - EASY LIGHT - 4000K				
		Lumen	LED power (W)	System power (W)
 PRUNUS A1		800	5.8	8
		1050	6.2	8.4
		1200	6.9	9.1
		1350	7.8	10
		1500	8.8	11
		1600	9.7	11.9
		1800	11.1	13.2
		2000	11.9	14
		2150	12.8	14.9
		2300	13.4	15.5
		2500	14.8	16.9
		2750	15.9	18.4
		3000	17.9	20

Product specifications

- colour temperature neutral white (4000K) or warm white (3000K)
- light cover: polycarbonate, clear
- weight: approx. 6 kg (depends on model)
- assembly-, installation- and maintenance-friendly
- pole-mounted size: 60 mm
- CRI: > 70
- voltage: 230/240 V, 50 Hz
- safety class: I
- wind surface: approx. 0.14 m²
- standard colour: RAL 7016
- standard cable type H05BQ-F (5 meter, 3x1.0 mm²)
- standard Surge Protection (CM/DM): 8 kV/6 kV
- expected lifespan 100,000 Hrs (L80/F10)

- Lavender White
- Sun Yellow
- Scarlet Red
- Sky Blue
- Eco Green
- Ocean Blue
- Evening Red



DECORATIVE ELEMENTS	
Product	
	Upper LED ring
	Lower LED ring

Colours may differ from brochure printed colours.

Options

- other RAL colour
- other cable types/lengths
- several dimming options: Dali, Dynadimmer (integrated in driver), 1-10 V
- safety class II
- various light distributions
- pole-mounted size 76 mm

RGB LED ring (optional)

- RGB LED ring: acrylic semi-transparent

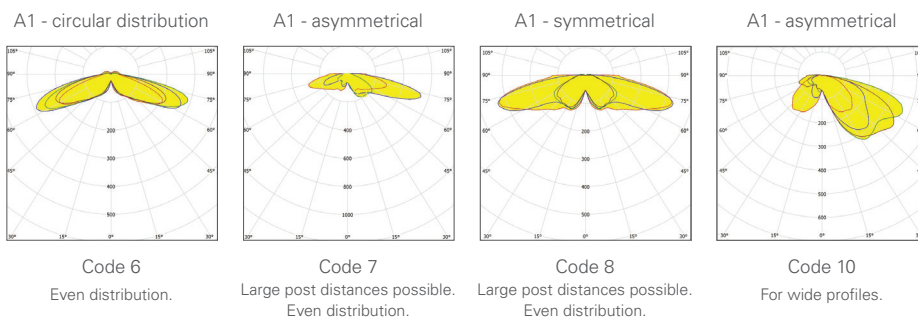
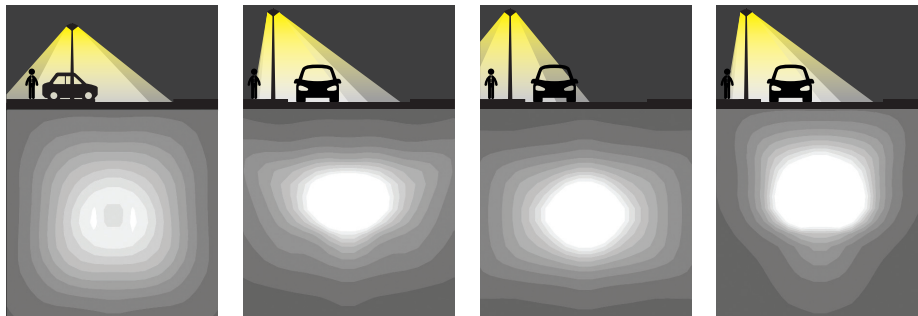

Visit our website for the most up to date information

www.lightronics.eu





STREET AND OUTDOOR LIGHTING - POLE TOP LUMINAIRE

One standard for all applications!



* Option

PRUNUS A2

Application areas

- Residential areas
- Plazas
- Parks
- Business parks
- Town and city centres
- Separate cycle paths

Top cover: aluminium, powder coated

Light cover: UV-stabilised polycarbonate, semi-frosted

Light source: LED

- IP 66
- IK 10
- CE

Dimensions in mm:

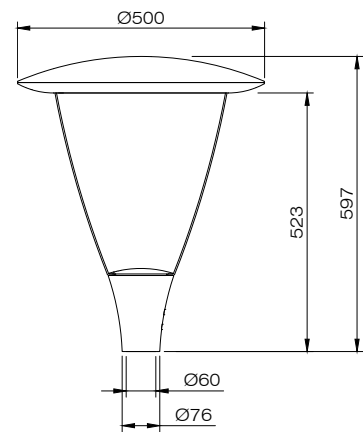



Technical specifications



POLE TOP LUMINAIRE - EASY LIGHT - 4000K				
		Lumen	LED power (W)	System power (W)
 PRUNUS A2		800	5.8	8
		1050	6.2	8.4
		1200	6.9	9.1
		1350	7.8	10
		1500	8.8	11
		1600	9.7	11.9
		1800	11.1	13.2
		2000	11.9	14
		2150	12.8	14.9
		2300	13.4	15.5
		2500	14.8	16.9
		2750	15.9	18.4
		3000	17.9	20

Product specifications

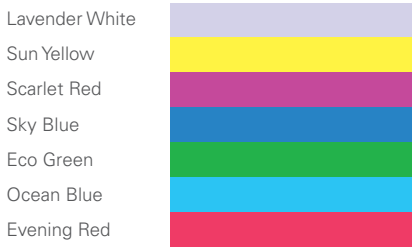
- colour temperature neutral white (4000K) or warm white (3000K)
- light cover: polycarbonate, semi-frosted
- weight: approx. 6 kg (depends on model)
- assembly-, installation- and maintenance-friendly
- pole-mounted size: 60 mm
- CRI: > 70
- voltage: 230/240 V, 50 Hz
- safety class: I
- wind surface: approx. 0.14 m²
- standard colour: RAL 7016
- standard cable type H05BQ-F (5 meter, 3x1.0 mm²)
- standard Surge Protection (CM/DM): 8 kV/6 kV
- expected lifespan 100,000 Hrs (L80/F10)



Colours may differ from brochure printed colours.

DECORATIVE ELEMENTS	
Product	
	Upper LED ring
	Lower LED ring

Options

- other RAL colour
- other cable types/lengths
- several dimming options: Dali, Dynadimmer (integrated in driver), 1-10 V
- safety class II
- various light distributions
- pole-mounted size 76 mm

RGB LED ring (optional)

- RGB LED ring: acrylic semi-transparent

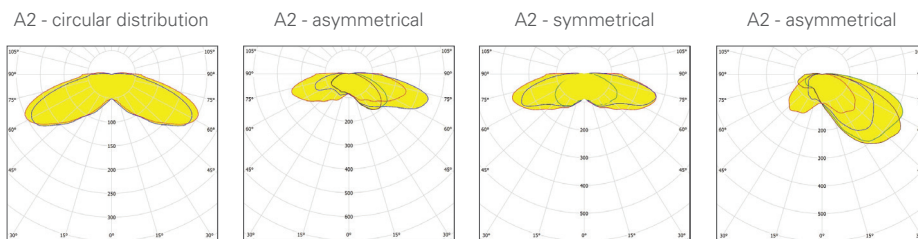
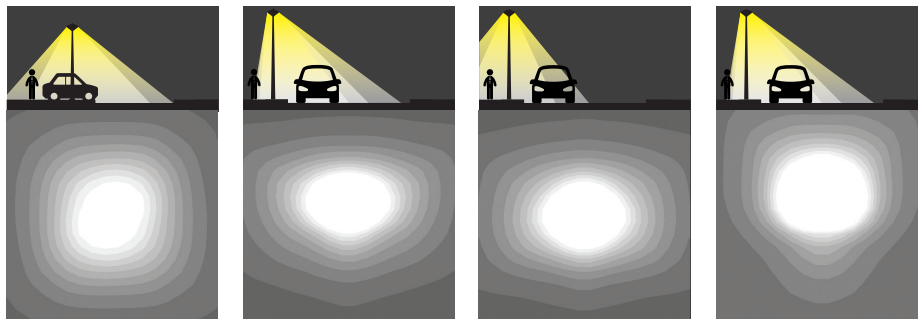

A2 - circular distribution
A2 - asymmetrical
A2 - symmetrical
A2 - asymmetrical

Code 6
 Even distribution. More comfort.

Code 7
 Large post distances possible. Even distribution. More comfort.

Code 8
 Large post distances possible. Even distribution. More comfort.

Code 10
 For wide profiles. More comfort.

Visit our website for the most up to date information

www.lightronics.eu





STREET AND OUTDOOR LIGHTING - POLE TOP LUMINAIRE





One standard for all applications!



* Option

PRUNUS A3

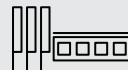
Application areas

- 
Residential areas
- 
Plazas
- 
Parks
- 
Business parks
- 
Town and city centres
- 
Separate cycle paths

Top cover: aluminium, coated
 Light cover: UV-stabilised polycarbonate, clear
 Light source: LED

- IP 66
- IK 10
- CE

Dimensions in mm:

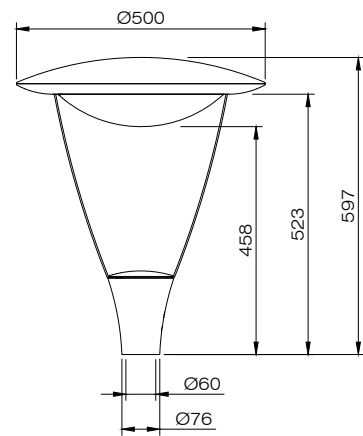



Technical specifications



POLE TOP LUMINAIRE - EASY LIGHT - 4000K				
		Lumen	LED power (W)	System power (W)
 PRUNUS A3		800	5.8	8
		1050	6.2	8.4
		1200	6.9	9.1
		1350	7.8	10
		1500	8.8	11
		1600	9.7	11.9
		1800	11.1	13.2
		2000	11.9	14
		2150	12.8	14.9
		2300	13.4	15.5
		2500	14.8	16.9
		2750	15.9	18.4
		3000	17.9	20

Product specifications

- colour temperature neutral white (4000K) or warm white (3000K)
- light cover: polycarbonate, clear
- lens cover: bowl-shaped optic, clear
- weight: approx. 6 kg (depends on model)
- assembly-, installation- and maintenance-friendly
- pole-mounted size: 60 mm
- CRI: > 70
- voltage: 230/240 V, 50 Hz
- safety class: I
- wind surface: approx. 0.14 m²
- standard colour: RAL 7016
- standard cable type H05BQ-F (5 metre, 3x1.0 mm²)
- standard Surge Protection (CM/DM): 8 kV/6 kV
- expected lifespan 100,000 Hrs (L80/F10)

- Lavender White
- Sun Yellow
- Scarlet Red
- Sky Blue
- Eco Green
- Ocean Blue
- Evening Red



DECORATIVE ELEMENTS	
Product	
	Upper RGB LED ring
	Lower RGB LED ring

Colours may differ from brochure printed colours.

Options

- other RAL colour
- other cable types/lengths
- several dimming options: Dali, Dynadimmer (integrated in driver), 1-10 V
- safety class II
- various light distributions
- pole-mounted size 76 mm

RGB LED ring (optional)

- RGB LED ring: acrylat semi-transparent

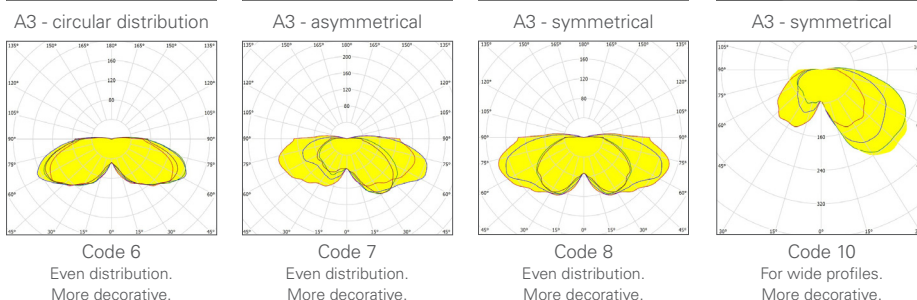
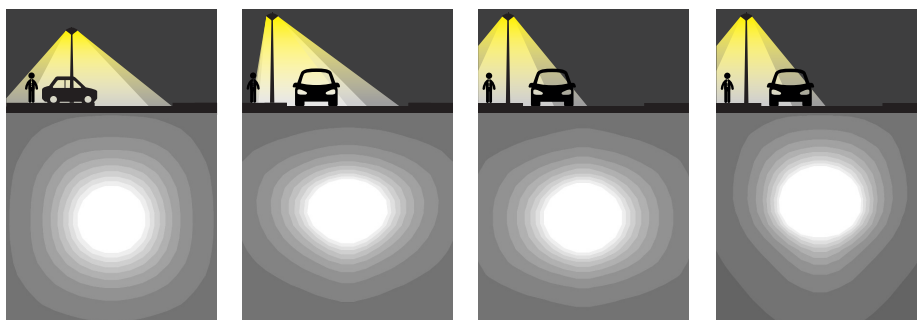

Visit our website for the most up to date information

www.lightronics.eu





STREET AND OUTDOOR LIGHTING - POLE TOP LUMINAIRE

One standard for all applications!



PRUNUS A4

Application areas

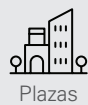

Top cover: aluminium, coated
 Light cover: UV-stabilised polycarbonate, clear
 Light source: LED

IP 66

IK 10



Dimensions in mm:

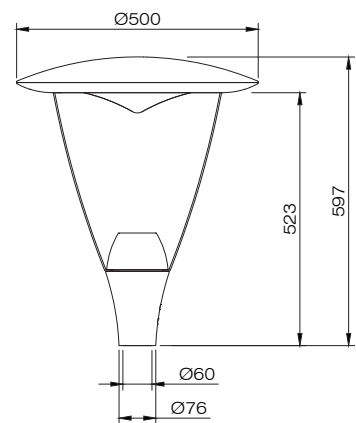

Technical specifications



POLE TOP LUMINAIRE - 3000K				
		Lumen	LED power (W)	System power (W)
	PRUNUS A4	1700	12.5	14

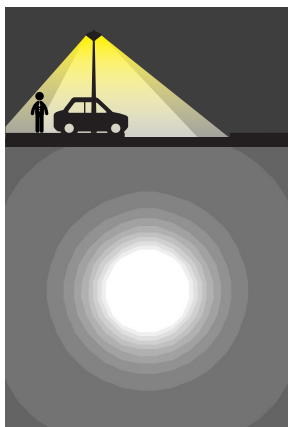

A4 - circular distribution

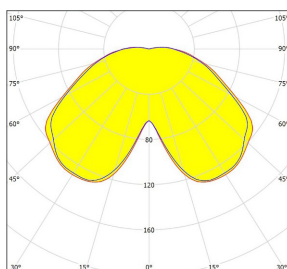

circular distribution

Product specifications

- colour temperature: standard warm white (3000K)
- light cover: polycarbonate, clear
- upward directed LED light source
- downward light distribution by white reflector
- weight: approx. 6kg (depends on model)
- assembly-, installation- and maintenance-friendly
- pole-mount size: 60 mm
- CRI: > 70
- voltage: 230/240 V, 50 Hz
- safety class: I
- wind surface: approx. 0.14 m²
- standard colour: RAL 7016
- standard cable type H05BQ-F (5 meter, 3x1.0 mm²)

Options

- other RAL colour
- other cable types/lengths
- safety class II
- colour temperature neutral white (4000K)

Visit our website for the most up to date information

www.lightronics.eu

